

# A study of nanoparticle manufacturing process using vacuum submerged arc machining with aid of enhanced ultrasonic vibration

HO CHANG\*, TSING-TSHIH TSUNG, CHIH-HUNG LO

*Department of Mechanical Engineering, National Taipei University of Technology, Taiwan, Republic of China*  
E-mail: f10381@ntut.edu.tw

HONG-MING LIN

*Department of Materials Engineering, Tatung University, Taiwan, Republic of China*

CHUNG-KWEI LIN

*Department of Material Science, Feng Chia University, Taiwan, Republic of China*

LIANG-CHIA CHEN

*Institute of Automation Technology, National Taipei University of Technology, Taiwan, Republic of China*

CHING-SONG JWO

*Department of Air-Conditioning and Refrigeration Engineering, National Taipei University of Technology, Taiwan, Republic of China*

---

This article presents the development of an innovative approach using the vacuum submerged arc machining with aid of enhanced ultrasonic vibration to manufacture nanoparticles. The Arc Spray Nanoparticle Synthesis System (ASNSS) previously designed by the NTUT's Nano Laboratory has been successfully developed to generate nanoparticles. In this proposed process, a titanium bar, as the electrode, is melted and vaporized in distilled water, used as an insulating liquid. Meanwhile, the ultrasonic vibration is applied to the electrode to remove the vaporized metal powders rapidly from the melting zone. The vaporized metal particles are then rapidly quenched by the designed cooling system, thus nanocrystalline particles nucleated and formed. This study discusses the influence of the ultrasonic amplitude and various process variables such as pulse duration, peak current, and dielectric liquid temperature on TiO<sub>2</sub> nanoparticles suspension. © 2005 Springer Science + Business Media, Inc.

---

## 1. Introduction

In 1962, Kubo, a Japanese thermodynamic scientist, presented a paper to announce that electronic energy levels of tiny metallic particles vary with the diameter of particle [1]. The characteristics of nanostructured materials are as follows [2–4]: (a) their atomic structures are different from those of ordinary solid crystalline phase or amorphous structures; (b) their properties, such as optical, magnetic, heat transmission, diffusive and mechanical properties, are different from those of traditional crystalline grains or amorphous materials; and (c) they enable alloys to be made from metals or polymers that cannot be mixed otherwise. Nanoparticles are prepared by both physical and chemical methods. The more traditional approach involves physical processing (grinding or ball-milling of larger particles, crystal

growing, ion implantation, and molecular epitaxy, for example) rather than chemical syntheses. Most of the researches have concentrated on production of components by EDM and have paid less attention on the production of debris (powder) of various sizes by this method. However, Soni [5] has related the formation of debris during rotary electrical discharge machining of titanium alloy and high carbon high chromium die steel. Many distinct types of spheroidal particles are witnessed and the mechanism of their formation has been discussed. Willey [6] has related the hollow, dented and cracked particles with solidification from the vapor phase in the dielectric. Murti and Philip [7] have analyzed the influence of ultrasonic vibrations on particle shape and size. Soni and Chakraverti [8] have presented the chemical analysis of debris and found

\*Author to whom all correspondence should be addressed.

that the debris of die steel was alloyed with the tool electrode material. All these reports showed that the produced particles were only in micro grade, but not nanoscale particles.

This research develops a manufacturing process known as vacuum submerged arc discharging enhanced by ultrasonic vibration, with a view of producing nanoparticles. The experimental device comprises mainly a heating system, an ultrasonic system, a pressure control system, and a temperature control system [9, 10]. The primary method adopted in this research involves using an electric arc as a heat source, to provide the energy necessary for the synthesis. The merit of using an electric arc as the heat source of a heating system is high power, the stability of the electric arc, the sophisticated technology about the control system of the electric arc, and low cost of system installation. After an electric arc has been generated, by an igniter, from the materials submerged in a liquid coolant held within a vacuum cavity, an ultrasonic vibrator provides vibrational energy to the vaporized metal (within the high-temperature fusion zone) generated by the electric arc so as to impose a suitable degree of disturbance to and impact upon the vaporized metal and eventually cause the vaporized metal to deviate from the fusion zone. The purpose of the aforesaid method is to enable the surrounding liquid coolant to function under a good low-temperature cooling system, so as to suppress the growth of metallic particles during the solidification process, with a view of producing nano-Titanium metallic particles characterized by a perfect distribution of particles.

The nanoparticles synthesized using the proposed method are of a suspension type, meaning they are dispersed in the fluid (deionized water). The nanoparticle suspension synthesized by the proposed method using better process variables already demonstrate good dispersion and even without dispersant, they can still remain in stable suspension for a fairly long time. In other words, the nanoparticle suspension prepared by this study is readily usable for subsequent research or application purposes. Hence its practical applicability is much enhanced. Moreover, all metallic materials whether they are ductile or brittle can be used to synthesize different material-based nanoparticle suspensions by the proposed method of this study.

## 2. Experimental

In general, all kinds of manufacturing processes of nano-structured materials should have the following five features [11]:

1. Gas Source—the vaporization source of the solid phase or the liquid phase.
2. Heat Source—provide the energy required for vaporization or chemical reactions.
3. Atmosphere—a vacuum or a space filled with an inert gas.
4. Manufacturing process parameters monitoring system—monitor the temperature, pressure and gas flow during the manufacturing process.
5. Powder collection system.

This study uses ultrasonic vibration to enhance the vacuum electric arc discharge system for the preparation of nanoparticles. The schematic diagram of the experimental setup is shown in Fig. 1. The main technique involved in the process includes the use of titanium bulk metal material to be produced as electrode and the integration of the device with an ultrasonic vibrator. The experiment device mainly comprises a heating system, an ultrasonic vibration system, a pressure control system, and a temperature control system. Fig. 2 shows the developed combined Arc Spray Nanoparticle Synthesis System. An Electrical Discharge Arc Heating System (the EDAHS) with 50 kW power used as an arc generator, was installed in the ASNSS. The vibrator used in the ultrasonic vibration system is a Lengevin-type piezoelectrical composite transducer with an input power of 150 W and a frequency of 19.5 KHz. The pressure control system is used to maintain an appropriate vacuum pressure inside the vacuum chamber. The constant temperature system is employed to maintain a desired and constant temperature of the dielectric liquid, in which the vaporized metal aerosol can be effectively nucleated, thus preventing excessive grain growth. The heating source generates a submerged arc to vaporize the metals, which are the electrodes. Applied electrical energy then produces heating source for generating an adequate arc with a high temperature ranging from 6000 to 12000°C. In the development process, a titanium and copper bar is melted and vaporized in deionized water, which is used as an insulating liquid. In addition, the

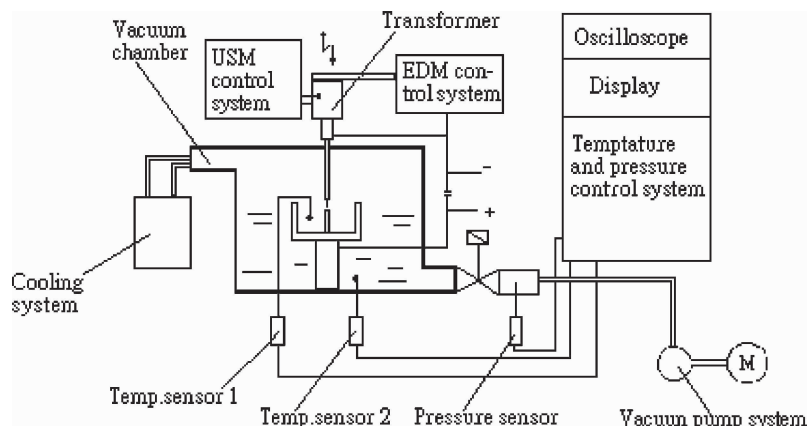

Figure 1 Schematic diagram of ultrasonic vibration electric arc system.



Figure 2 Facilities for nanoparticle suspension preparation by ASNSS.

dielectric liquid is vaporized by part of the submerged arc rapidly while the metal electrodes are heated. Water vapor with high pressure is generated by the inertia force of the surrounding dielectric liquid (deionized water). The vapor promotes effectively a rapid removal of the vaporized aerosol from the electrodes. Then, the vaporized aerosol present in the dielectric liquid changes its current phase state through the nucleating, growing and solidifying stages, and eventually becomes metal nanoparticles dispersed in the dielectric liquid. This study integrates the ultrasonic vibration system in ASNSS. The main function of ultrasonic vibration is to increase the stability of the electric arc. In addition, the energy released by the ultrasonic vibration can generate minute disturbance and impact on the discharge fusion zone, which makes the gasified metal easier to be removed from the fusion zone and be quickly cooled down by the low-temperature dielectric fluid surrounding it, thereby obtaining smaller nanoparticles.

To facilitate the investigation on the effect of the current and the cooling temperature on the distribution of particles and the size of particles of the nanoparticles produced by the manufacturing process, the experiments of this research are planned in such a way that, the effect of current on the manufacturing process that works without and with the aid of ultrasonic vibration are compared and analyzed first. Then, the effects of different cooling temperatures on the nanoparticles produced by the manufacturing process that works with the aid of ultrasonic vibration at a fixed current of 0.5 A are studied. Table I shows the manufacturing process parameters for these two stages of experiments. At the end of the experiments, particle sizes and grains agglomeration phenomenon are observed under a transmission electron microscope (TEM). The distribution of particle size is analyzed with the HORIBA LB-500 Particle Size Distribution Analyzer. The crystal structure of the nanoparticles produced by the manufacturing process is tested by X-ray diffraction (XRD).

### 3. Results and discussion

As regards the first-stage manufacturing process control parameters, the operating temperature is set at 0.4°C, with a deviation range of  $\pm 0.2^\circ\text{C}$ , and

TABLE I Experimental parameters for two stage process

Working condition	First-stage	Second-stage
Peak current (A)	0.5, 3, 7	0.5
Temperature of dielectric fluid ( $^\circ\text{C}$ )	0.4	0.4, 5.4, 10.4
Discharge time (hr)	1.5	1.5
Electrode	Titanium	Titanium
Dielectric fluid	Deionized water	Deionized water
Breakdown voltage (V)	110	110
Pulse duration ( $\mu\text{s}$ )	25	25
Amplitude of ultrasonic vibration ( $\mu\text{m}$ )	8	8
Off time ( $\mu\text{s}$ )	100	100
Capacity of deionized water (ml)	130	130

the pressure within the vacuum cavity is 20 Torr (same as the second-stage), while the other discharge processing parameters are shown in Table I. Fig. 3 depicts a curve of the distribution of particle size acquired by the manufacturing process that works without the aid of ultrasonic vibration, when the current is 0.5 A. The figure shows that the average size of the particles was 460 nm. A calculation of the distribution of particle diameters reveals that 59.4% of the particles produced have particle number greater than 5%. Fig. 4 depicts a curve of the distribution of particle size acquired by the manufacturing process that works with the aid of ultrasonic vibration, when the current is 0.5 A. The figure shows that the average size of the particles was 531.2 nm, with 77.% of the

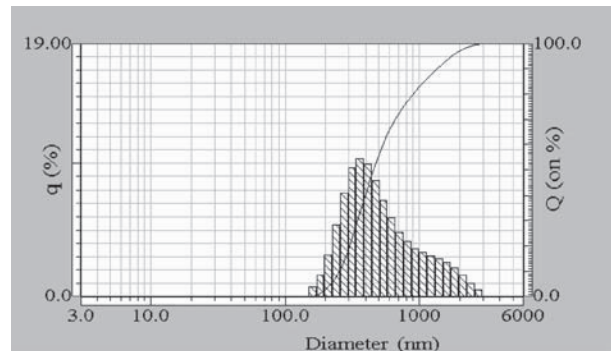

Figure 3 Particle size distribution without the aid of ultrasonic vibration (current 0.5 A).

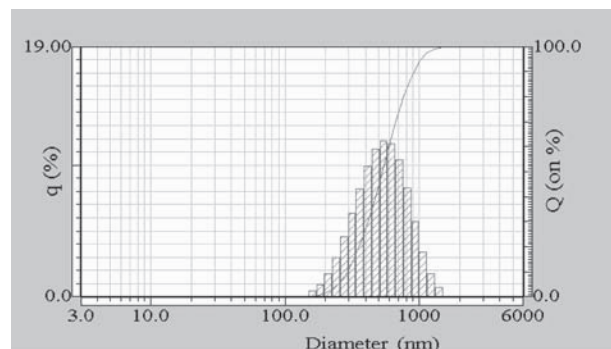

Figure 4 Particle size distribution with aid of ultrasonic vibration (current 0.5 A).

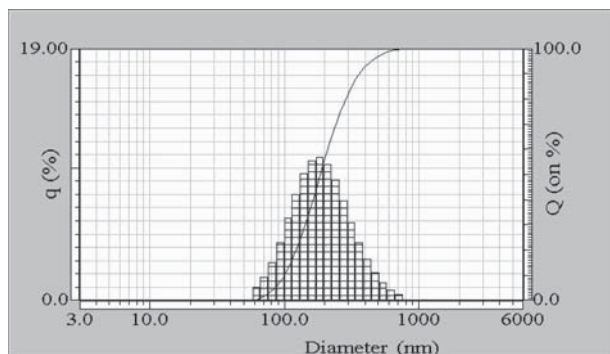

Figure 5 Particle size distribution without the aid of ultrasonic vibration (current 3 A).

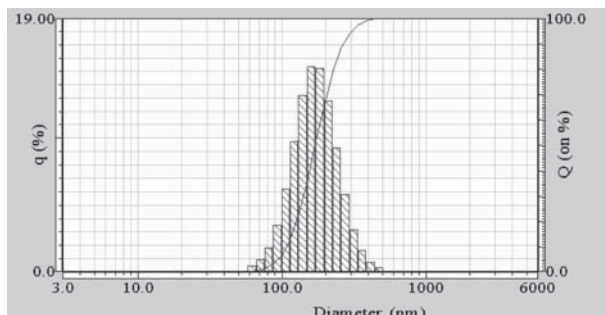

Figure 6 Particle size distribution with aid of ultrasonic vibration (current 3 A).

particles produced have particle number greater than 5%. The analysis conducted on Figs 3 and 4 indicates that, given the same discharging processing condition, a manufacturing process that works with the aid of ultrasonic vibration enhances the centralizing feature of the particles and shifts the curve of distribution of particle size rightward, that is, producing larger particles. Fig. 5 depicts a curve of the distribution of particle size acquired by the manufacturing process that works without the aid of ultrasonic vibration, when the current is 3 A. The figure shows that the average size of the particles was 184.9 nm. A calculation of the distribution of particle size reveals that 71.6% of the particles produced have particle number greater than 5%. Fig. 6 depicts a curve of the distribution of particle size acquired by the manufacturing process that works with the aid of ultrasonic vibration, when the current is 3 A. The figure shows that the average size of the particles was 180.5 nm, with 84.7% of the particles produced have particle number greater than 5%. The above findings show that, given the same discharging processing condition, ultrasonic vibration enhances the centralizing feature of the particles. The above experiments are conducted again with a current greater than 7 A, about an hour after the experiment, precipitation is found in the solution acquired. The precipitations are almost transparent and thus it is impossible to study their distribution of particle diameter with a particle size distribution analyzer. As indicated by the analysis of the above experiments, when current is less than 7 A, ultrasonic vibration enhances the centralizing feature of the particles. As regards the second-stage manufacturing process control parameters, the current

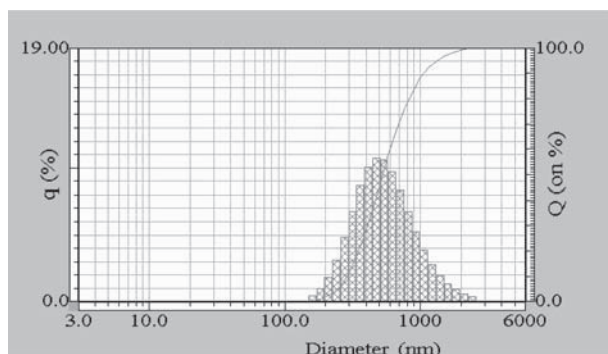

Figure 7 Particle size distribution with aid of ultrasonic vibration (temperature 0.4°C).

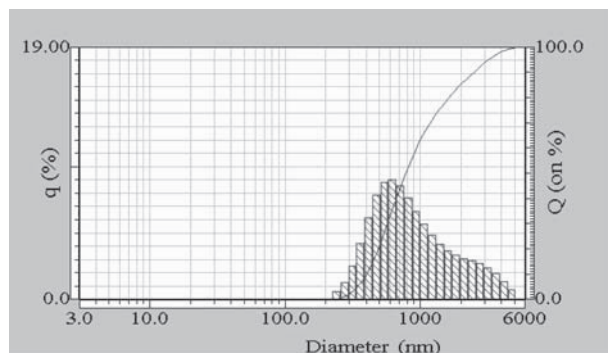

Figure 8 Particle size distribution with aid of ultrasonic vibration (temperature 10.4°C).

is set at 1.5 A, while the other discharge processing parameters are shown in Table I. In Fig 7, with a temperature of the processing solution of 0.4°C, the curve of the distribution of particle size shows that the average size of the particles was 526.4 nm and 70.1% of the particles produced have particle number greater than 5%. In Fig. 8, with a temperature of the processing solution of 10.4°C, the curve of the distribution of particle size shows that the average size of the particles was 780.2 nm and 54.2% of the particles produced have particle number greater than 5%. Figs 7 and 8 show that, given the same processing condition, a rise in the processing temperature shifts the curve of the distribution of particle size rightward, that is producing bigger particles, but the particles produced are characterized by poor centralizing feature.

Fig. 9 shows the relationship between pulse duration and particle size at a current of 2.25 A and 4.5 A respectively. As the figure indicates, when the current is 4.5 A, with pulse duration growing from 2  $\mu$ s to 200  $\mu$ s, the mean particle size of the particles suspension will increase from 45 nm to 250 nm, while under a current of 2.25 A with pulse duration growing from 2 to 200  $\mu$ s, the mean particle size of the suspended particles will increase from 85 nm to 323 nm. Seen from Fig. 9, it is clear that pulse duration has a great influence on the mean size of the particles produced. In other words, only with smaller pulse duration will it be possible to obtain nano-level particles.

The amplitude of ultrasonic vibration is an important variable in the ultrasonic system. In order to understand the influence of amplitude on the preparation of

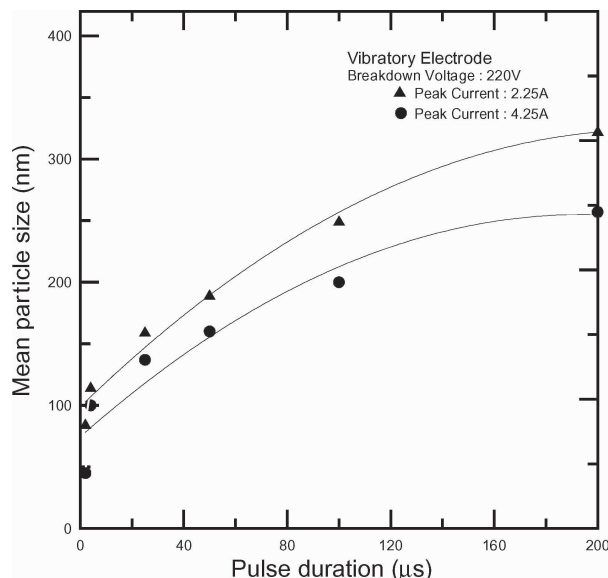

Figure 9 Relationship between pulse duration and mean particle size.

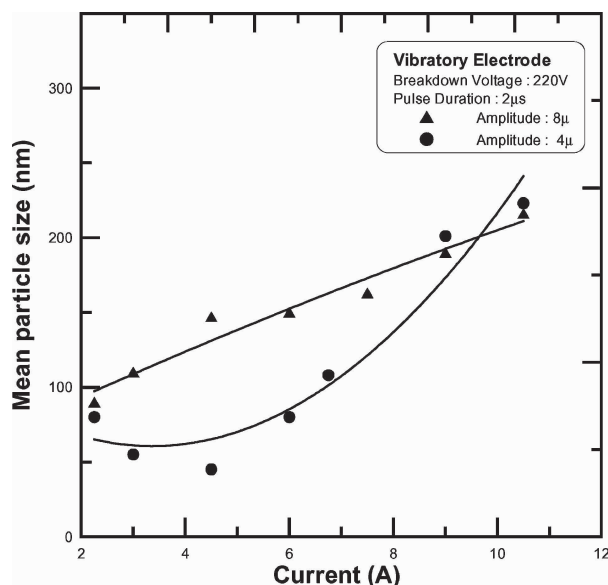

Figure 10 Relationship between current and mean particle size under ultrasonic vibration assisted process with various amplitudes.

nanoparticles, the experiment sets the pulse duration at  $2 \mu\text{s}$ , in order to find out the relationship between current and nanoparticles size under varying amplitudes of ultrasonic vibration. The result is summarized in Fig. 10. As the figure indicates, when the current is below 9 A, the particles produced under an amplitude

TABLE II Process variables contributing to the production of relatively ideal  $\text{TiO}_2$  nanoparticle suspensions

Working condition	Description
Breakdown voltage (V)	220
Peak current (A)	4
Pulse duration ( $\mu\text{s}$ )	2
Off time ( $\mu\text{s}$ )	2
Pressure (Torr)	20
Temperature of dielectric fluid ( $^{\circ}\text{C}$ )	0
Ultrasonic frequency (kHz)	19.5
Amplitude of ultrasonic vibration ( $\mu\text{m}$ )	4

of  $8 \mu\text{m}$  have a mean size larger than those prepared under an amplitude of  $4 \mu\text{m}$ . But when the current exceed 9 A, the mean size of the particles prepared under an amplitude of  $4 \mu\text{m}$  may exceed that of particles prepared under an amplitude of  $8 \mu\text{m}$ . As Fig. 10 reveals, with smaller amplitude and specific current, nano-level particles can be obtained.

The nanoparticle suspension prepared under better process variables identified in the experiment is summarized in Table II. Fig. 11 a and b are the TEM image of

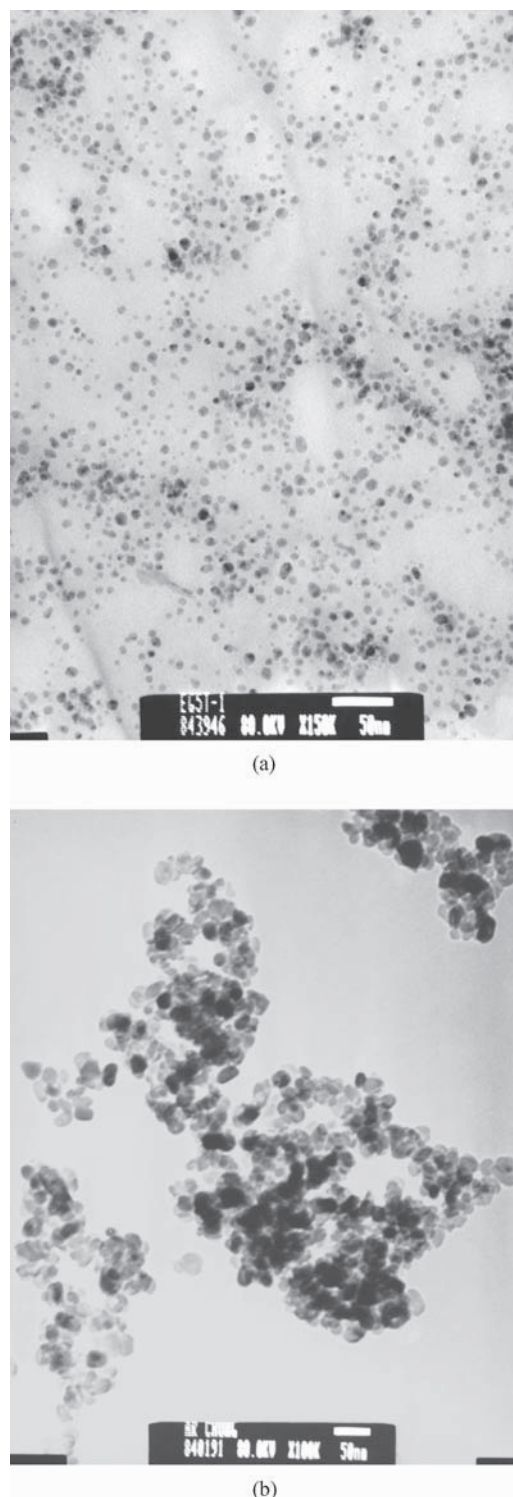

Figure 11 TEM image of  $\text{TiO}_2$  nanoparticle suspension prepared using better process variables: (a) with the aid of ultrasonic vibration (b) without the aid of ultrasonic vibration.

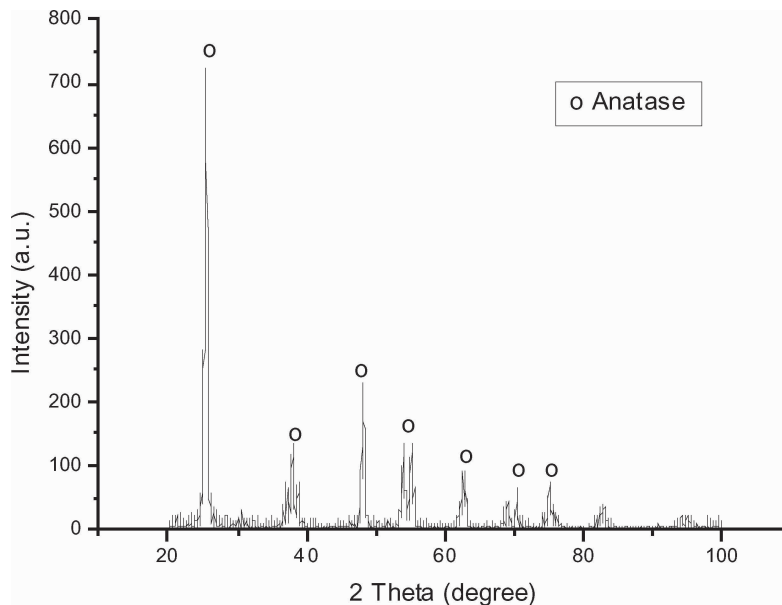

Figure 12 The XRD pattern of Ti particle after oxidized to  $\text{TiO}_2$ .

the nanoparticle suspension prepared using the process variables in Table II. As shown in Fig. 11a, with aid of ultrasonic vibration which indicates good nanoparticle dispersion with a mean particle size below 10 nm. Comparing Fig. 11a with b shows that the size of nanoparticles obtained without ultrasonic vibration is larger than that with and that some nanoparticles aggregate together, implying a relatively poor dispersion. The high frequency variation of the liquid pressure can improve the liquid flow behavior substantially, and can avoid the accumulation of erosive product sediment. The ultrasonic vibration of the electrode prevents the sedimentation of the nanoparticles in the working gap and results in their animated suspension in the deionized water, which improves the deionized water circulation. These features increase the discharge efficiency substantially and improve the state of dispersion of nanoparticle suspension. On the other hand, the cavitation produced by the electrode ultrasonic vibration can re-boil the fusion metal in the erosion crater because of the sudden pressure drop. This process accelerates the fusion metal ejection from the erosion crater and reduces liquid metal re-casting on the machining surface. The nanoparticle suspension synthesized by the proposed method using better process variables already demonstrate good dispersion and even without dispersant, they can still remain in stable suspension for a fairly long time.

The XRD pattern of the nanoparticles produced by the manufacturing process with the aid of ultrasonic vibration as shown in Fig. 12. The XRD pattern indicates that the particles is anatase type of  $\text{TiO}_2$ .

#### 4. Conclusions

The manufacturing process, Vacuum Submerged Arc Discharging Enhanced by Ultrasonic Vibration, developed by this research, has successfully produced  $\text{TiO}_2$  nanoparticle suspension by means of the traditional discharging processing machines. From the experimental results and the discussion above, the following conclusions are made.

1. Ultrasonic vibration-assisted process can enhance the conventional vacuum arc spray process and can successfully produce nanoparticles. The high frequency variation of the liquid pressure can improve the liquid flow behavior substantially, and can avoid the accumulation of erosive product sediment.

2. The peak current is one of the important parameters in the whole manufacturing process variables. Among the process variables, smaller pulse duration, lower dielectric liquid temperature, and smaller ultrasonic amplitude are found to be conducive to the production of fine nanoparticles.

3. The nanoparticles synthesized using the proposed method are of a suspension type. In other words, the nanoparticle suspension prepared by this study is readily usable for subsequent research or application purposes. Hence its practical applicability is much enhanced.

4. The cost of this kind of ultrasonic vibration-assisted ASNSS is very low, thus this new kind of manufacturing method has an advantage in cost and production competition.

#### References

1. KUBO, *J. Phys. Soc. Japan* **17** (1962) 975.
2. H. FROES and C. SRUYANARAYANA, *JOM* **June** (1989) 12.
3. R. BIRRINGEN, *Mater. Sci. Engng.* **A117** (1989) 33.
4. R. P. ANDRES and R. S. ARERBACK, *et al.*, *J. Mater. Res.* **4**(3) (1989) 704.
5. J. S. SONI, *Wear* **177** (1994) 71.
6. P. WILLEY, in Proc. IEE Conf., Electromethods of Machining, Forming and Coating (1975) p. 265.
7. V. S. R. MURTI and P. K. PHILIP, *Wear* **117**(2) (1987) 241.
8. J. S. SONI and G. CHAKRAVERTI, in Proc. AMPT 1993 Conf. (Dublin, Ireland, 1993) p. 755.
9. T. T. TSUNG, H. CHANG, L. C. CHEN, L. L. HAN, C. H. LO and M. K. LIU, *Jpn. Inst. Metals* **44** (2003) 1138.
10. H. CHANG, T. T. TSUNG, L. C. CHEN, Y. C. YANG, H. M. LIN, L. L. HAN and C. K. LIN, *ibid.* **45** (2004) 806.
11. X. M. DAI and J. L. WANG, *Chinese Powder Technology* **5**(6) (1999) 28.

Received 3 September 2002

and accepted 20 September 2004